

# ENVISAT Microwave Radiometer Assessment Report

**Cycle 074**

**17-11-2008 – 22-12-2008**

(CCN No 1 to ESRIN Contract 21518/08/I-OL)

Prepared by :	B. PICARD, CLS M. CHENNAOUI, CLS M-L Frery, CLS	
Checked by :	B. SOUSSI, CLS	
Approved by :	P. FEMENIAS, ESA	



# Contents

<b>1</b>	<b>Introduction</b>	<b>4</b>
<b>2</b>	<b>Synthesis</b>	<b>5</b>
2.1	Conclusion for cycle 074 . . . . .	5
2.2	Long term monitoring . . . . .	5
<b>3</b>	<b>Significant events during cycle 074</b>	<b>8</b>
3.1	Gain survey . . . . .	8
3.2	Sky horn and hot load counts survey . . . . .	9
3.3	Residual temperature survey . . . . .	10
3.4	Cold ocean Tb monitoring . . . . .	10
<b>4</b>	<b>Long-term trends and former significant events</b>	<b>12</b>
4.1	Gain survey . . . . .	12
4.2	Sky horn and hot load counts survey . . . . .	14
4.3	Residual temperature survey . . . . .	16
<b>A</b>	<b>Monitoring of the radiometer internal parameters</b>	<b>18</b>
<b>B</b>	<b>References</b>	<b>19</b>

# List of Figures

1	Time evolution of the gain (zoom on the last 3 cycles). . . . .	8
2	Time evolution of the sky horn (top) and hot load (bottom) counts (zoom on the last 3 cycles). . . . .	9
3	Time evolution of the residual temperature TE (zoom on the last 3 cycles). . . . .	10
4	Cold Ocean brightness temperature for the 23.8 Ghz channel (top) and the 36.5 GHz channel (bottom) (90 days running average). . . . .	11
5	Time evolution of the gain since Envisat launch. . . . .	13
6	Time evolution of the sky horn (top) and hot load (bottom) counts since Envisat launch. . . . .	15
7	Time evolution of the residual temperature TE since Envisat launch. . . . .	17
8	Scheme of one channel of the MWR . . . . .	18

## Editing modifications

---

<b>Version</b>	<b>Date</b>	<b>Object</b>
1.0	November 2009	Creation of the document.

# 1 Introduction

---

This document aims at reporting on the behavior of the ENVISAT Microwave Radiometer in terms of instrumental characteristics and quality of the brightness temperatures for cycle 074.

It is performed on the MWR level 1B data product. The decoding and pre-processing are done with the MWR level 1B reference processing chain located at CLS, using MWR level 0 data product as input (MWR\_NL\_OP). The data are from the ESA's ground stations in Kiruna, Sweden, and at ESRIN, Italy.

The objectives of this document are :

- To provide an instrumental status
- To check the stability of the instrument
- To report any change at the instrumental level likely to impact quality of the brightness temperatures

It is divided into the following topics:

- **Synthesis of cycle 074 events and long term monitoring**
- **Significant events during cycle 074**
- **Long-term trends and former significant events**

## 2 Synthesis

---

### 2.1 Conclusion for cycle 074

- **No particular event during cycle 074**
- **Missing data at the end of the cycle are due to ftp transfer issue and not to instrument unavailability.**

### 2.2 Long term monitoring

The monitoring of the main instrumental parameters of the radiometer up to cycle 074 shows a drift of the 36.5 GHz channel. It appears that the gain, the sky horn counts, and the hot load counts have decreased between 3 and 26.32% since launch.

Two incidents occurred during the **cycle 71**:

- Unavailable MWR L0 data period in Kiruna station from 05/09/08 to 07/09/08
- A step is observed the 28 Aug 2008 on the hot counts, cold counts and residual temperature for the 36.5GHz channel.

Following a Payload HSM anomaly, no data are available from 17/01 8:50 to 17/01 18:41 during **cycle 65**.

Two planned unavailability periods occurred during **cycle 64**:

- From 03 Dec 2007 22:00:00 (orbit 30115) to 04 Dec 2007 15:08:24 (orbit 30125) due to planned payload unavailability for OCM and maintenance
- From 13 Dec 2007 06:44:00 (orbit 30249) to 13 Dec 2007 12:25:49 (orbit = 30252) for memory maintenance

Following an anomaly within the on-ground mission control software, no data are available during the first four days of **cycle 62** (24/09 to 27/09).

Following an anomaly within the on-ground mission control software, no data are available during the last nine hours of the **cycle 61** (24/09/2007).

Due to Telemetry error during **cycle 60**, the data from 29/07 to 30/07 are missing. After a transition period, instrumental parameters are back to nearly nominal values.

An incident has occurred during **cycle 58** between 26/05/2007 and 30/05/2007. After a short transition period, the data are back to nominal.

A big spike is also observed on 01/02/05 (**cycle 44**) for 23.8 GHz and 36.5 GHz channels.

A platform incident has occurred during **cycle 46**, between 06/04/06 and 09/04/06.

The residual temperature is now 3.50 times higher in absolute value than the one estimated at the beginning of the mission and 4-6 times higher than the one expected from ground testing. No explanation was provided up to now. These features should impact the 36.5 GHz brightness temperature as reported in (Obligis et al, 2003). But as seen in the monitoring of the cold ocean brightness temperatures through the different previous reports the slope of the derived regression line varies at each cycle which makes the quantification of the real impact difficult since the variation observed on the cold TB is a combination of the instrumental features and the annual natural cycle.

The table below sums up main monitoring anomalies observed since ENVISAT cycle 36 :

CycleNumber	Type of event	Date	Impacted Monitoring parameters
71	Quality	28/08/08	Cold counts, hot counts and residual temperature step down for 36.5GHz channel
71	Unavailability	05/09/08 to 07/09/08	Unavailable MWR L0 data period
65	Unavailability	17/01/08 to 17/01/08	Payload HSM anomaly
64	Unavailability	13/12/07 to 13/12/07	Planned unavailability for memory maintenance
64	Unavailability	03/12/07 to 04/12/07	Planned payload unavailability for OCM and maintenance
62	Unavailability	24/09/07 to 27/09/07	Unavailable MWR L0 data period. (anomaly within the on-ground mission control software)
61	Unavailability	24/09/07 to 24/09/07	Unavailable MWR L0 data period. (anomaly within the on-ground mission control software)
60	Unavailability	29/07/07 to 30/07/07	Unavailable MWR L0 data period. (Telemetry error)
58	Unavailability	26/05/07 to 30/05/07	MWR switched to Standby/Refuse mode after CEU (Central Electronic Unit) temperature uniformity flag was set to one. The situation was back to nominal after a COLD RESET of the DORIS/MWR ICU
53	Unavailability	30/11/06 and 15/12/06	Two unavailable MWR L0 data periods.
51	Unavailability	26/09/06 to 01/10/06	Unavailable MWR L0 data period.
51	Unavailability	07/09/06 to 11/09/06	Unavailable MWR L0 data period.
46	Quality	09/04/06	Gain loss, sky horn counts and hot load counts spikes for both channels.
44	Quality	01/02/06	Big spike on gain and TE values for both channels.
41	Quality	21/09/05	Spike on cold ocean TB values for both channels.
36	Quality	24/04/05	Gain values and sky horn counts step down for 36.5 GHz channel.

Table 1: Main monitoring anomalies observed from cycle 36



### 3 Significant events during cycle 074

To monitor the instrument behaviour during its lifetime, the key parameters are plotted in figures 1, 2 and 3: gain (after correction of the thermal variations, modeled as a parabolic function), hot load and sky horn counts, and the residual term TE (residual temperature contribution due to errors in the estimated coefficients). The instrument stability is ensured if none of these parameters do vary with time (see the following paragraphs 3.1, 3.2 and 3.3).

On the other hand, to assess the long term stability of the MWR radiometer, a monitoring of the two brightness temperatures was performed by selecting the coldest measurements over ocean, as shown in figure 4. This method, derived from Ruf's one for TMR (Ruf, 2000), was found to be the most efficient to point out the slight trend of the ERS2 23.8 GHz channel (Eymard et Obligis, 1999; Eymard et al, 2002) (see the following paragraph 3.4).

#### 3.1 Gain survey

Figure 1 represents the gains of the two channels 23.8 and 36.5 GHz on the last three cycles.

The updated total decrease on channel 2 (36.5 GHz) is about 26.32% (from 10.4 at the beginning to about 7.663 now)

**No particular event during this cycle 74.**

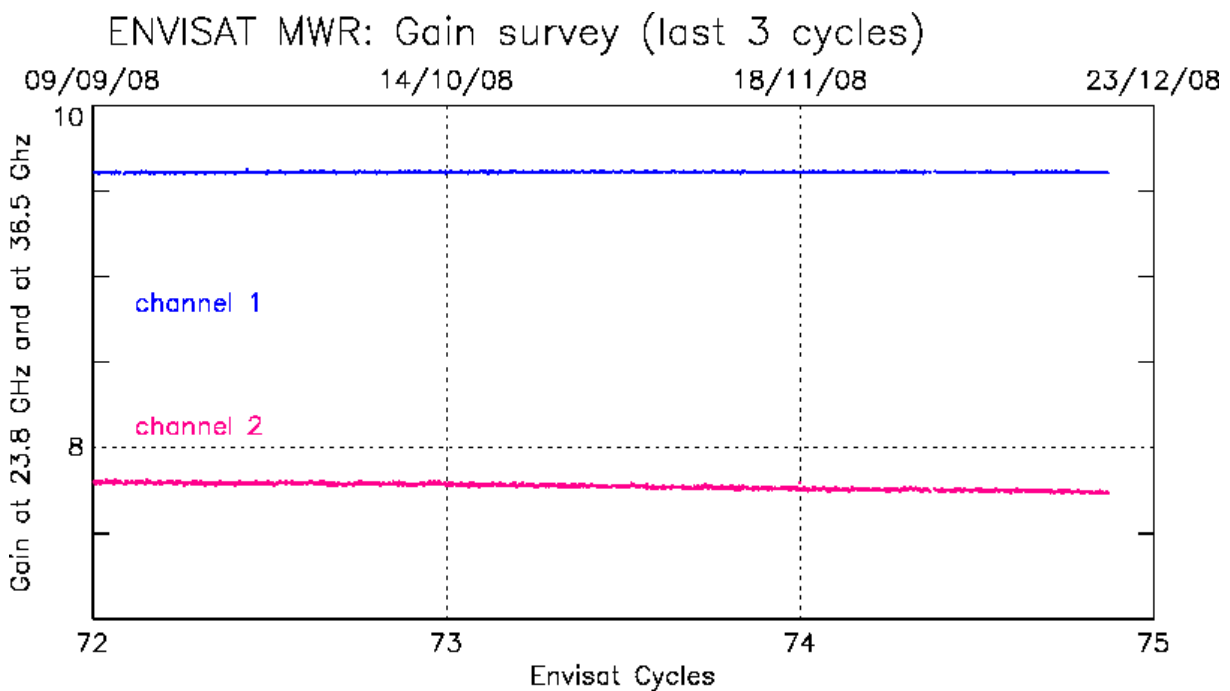

Figure 1: Time evolution of the gain (zoom on the last 3 cycles).

### 3.2 Sky horn and hot load counts survey

**No particular event during this cycle 074.**

**Figure 2** represents the counts of the two channels 23.8 and 36.5 GHz for the sky horn (top), and for the hot load (bottom).

The updated total decrease of sky horn counts on channel 2 (36.5 GHz) is about -22.69% (from 3600 at the beginning to about 2783 now).

The updated total decrease of hot load counts on channel 2 (36.5 GHz) is about -5.30% (from 660 at the beginning to about 625 now).

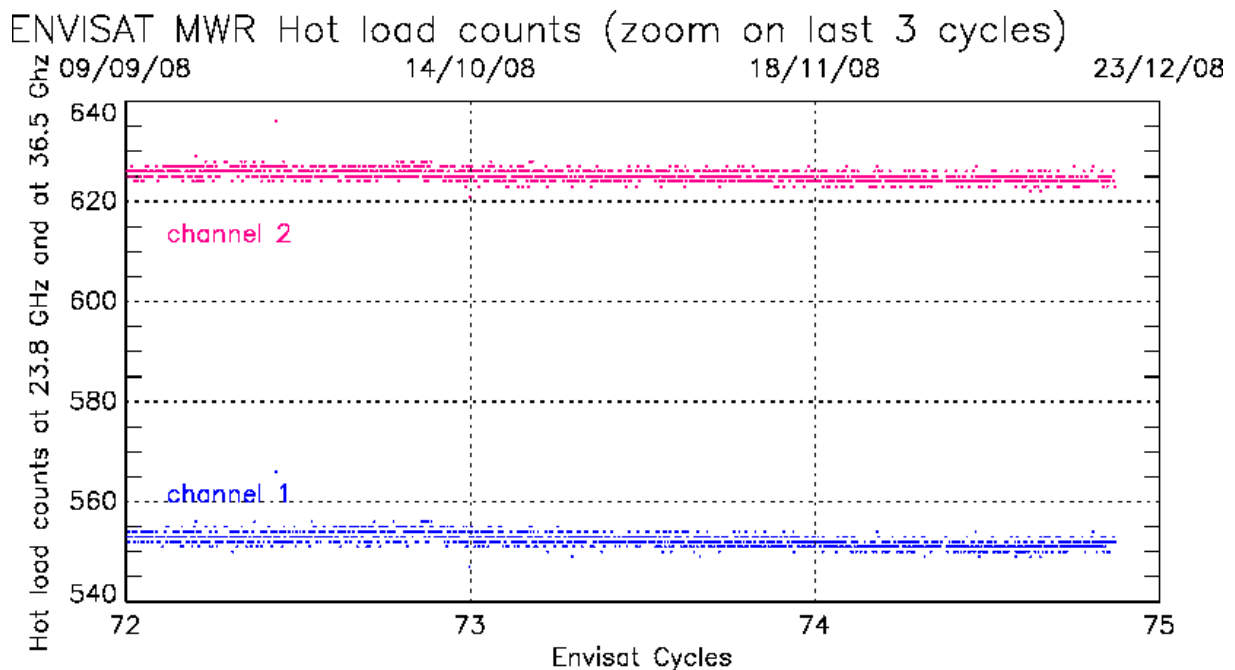
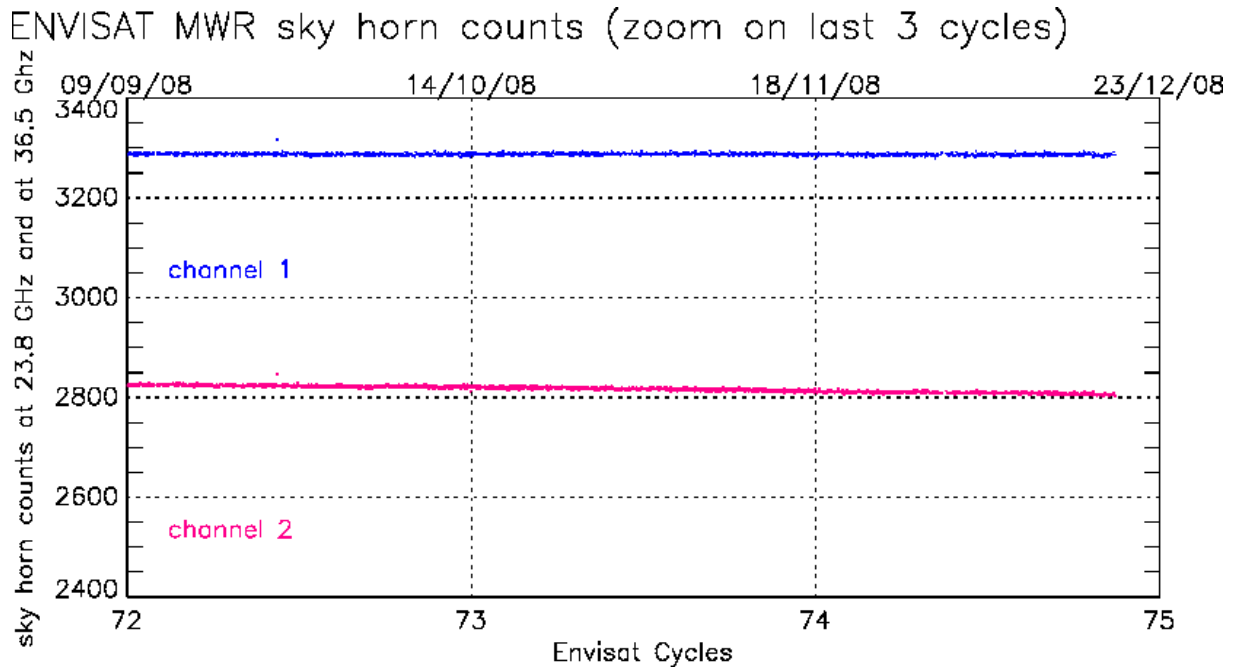

Figure 2: Time evolution of the sky horn (top) and hot load (bottom) counts (zoom on the last 3 cycles).

### 3.3 Residual temperature survey

No particular event during this cycle 074.

Figure 3 represents the residual temperature of the two channels 23.8 and 36.5 GHz since Envisat launch (top), and on the last three cycles (bottom).

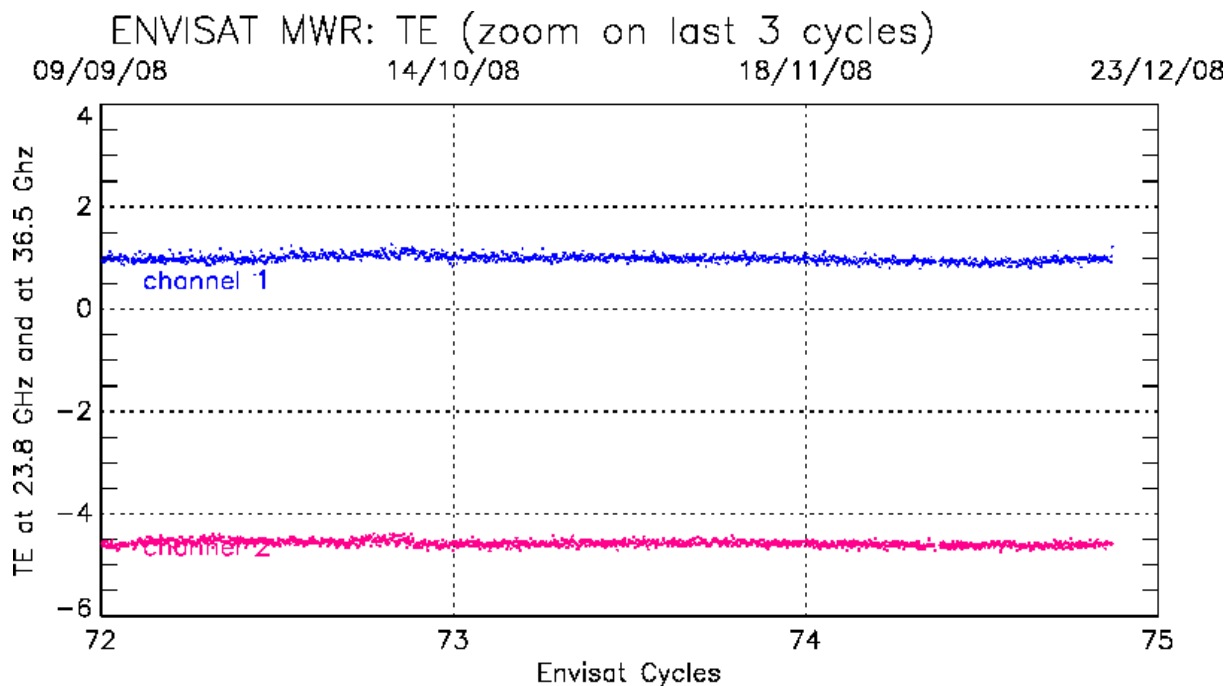

Figure 3: Time evolution of the residual temperature TE (zoom on the last 3 cycles).

### 3.4 Cold ocean Tb monitoring

Following the method explained above and using a threshold equal to the average minus the standard deviation, the Envisat resulting time series is plotted, after a 90-days running average, in figure 4. This running average leads to a small delay between the current cycle and the last available values of the cold ocean Tb monitoring.

For the first channel, the cold ocean TB values present a -0.0370 K/year variation, while a variation of -0.033 K/year is observed for the second one.

On both channels, the cold ocean Tb are the most cold from cycle 29 to cycle 52 for the 23.8 GHz channel and from cycle 43 to cycle 52 for the 36.5 GHz channel (apart from the stabilization period, cycle 4 to 16). Since this phenomenon is observed on both channels, a geophysical origin is considered.

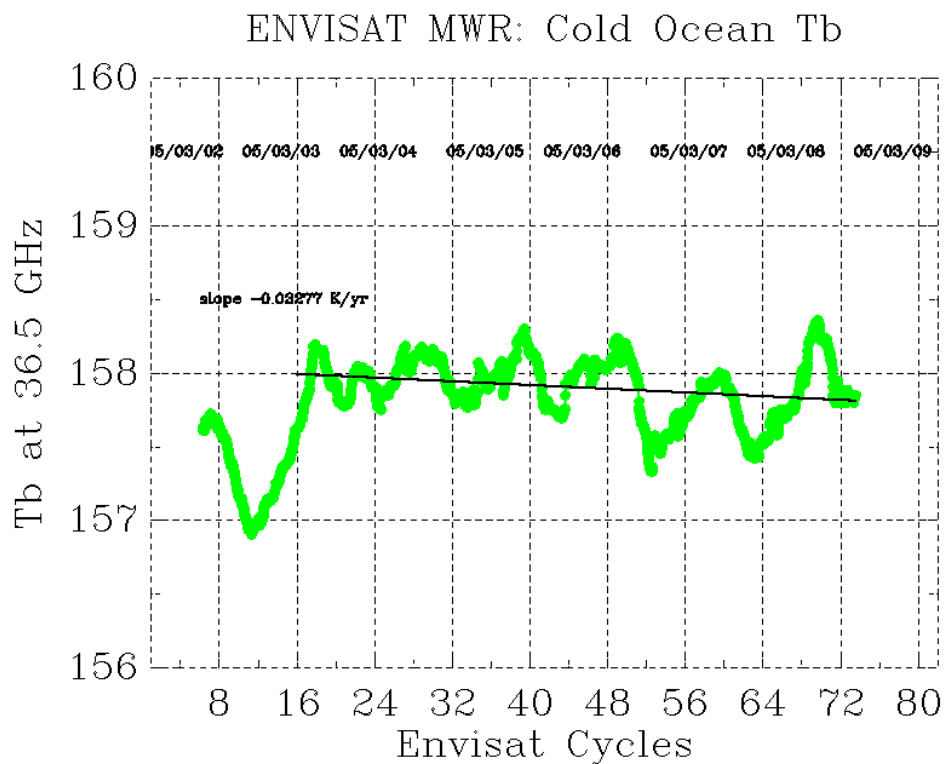
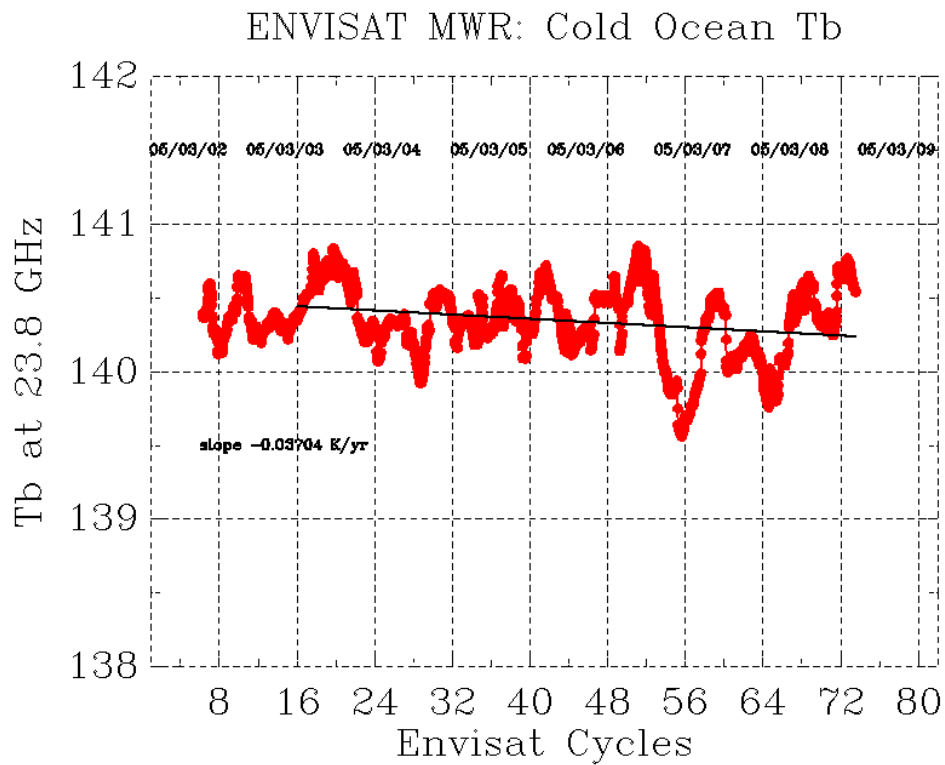

Figure 4: Cold Ocean brightness temperature for the 23.8 Ghz channel (top) and the 36.5 GHz channel (bottom) (90 days running average).

## 4 Long-term trends and former significant events

---

### 4.1 Gain survey

**Figure 5** shows that the gain in the 23.8 GHz channel remains stable around 9.6. For the second channel, the evolution shows two decreasing trends, small at the beginning and a stronger one since cycle 8. The total decrease is about 26.32% (at 10.4 at the beginning and about 7.663 now).

During **cycle 71**, no MWR L0 data are available in Kiruna station from the 05 Sep 2008 to 07 Sept 2008. A step down is observed for the hot and cold counts of the 36.5 GHz channel.

During **cycle 71**, no MWR L0 data are available in Kiruna station from the 05 Sep 2008 to 07 Sept 2008. Following a Payload HSM anomaly, no data are available from 17/01 8:50 to 17/01 18:41 during **cycle 65** with no particular impact on the gain.

Two planned unavailability periods (03/12 to 04/12 and 13/12 from 6 am to 12 am) during the **cycle 64** with no particular impact on the gain.

Following an anomaly within the on-ground mission control software, no data are available during the first four days of **cycle 62** (24/09 to 27/09). After a short transition period, the gain has regained nominal values.

Following an anomaly within the on-ground mission control software, no data are available during the last nine hours of the **cycle 61** (24/09/2007).

Due to Telemetry error during **cycle 60**, the data from 29/07 to 30/07 are missing. After a transition period, instrumental parameters are back to nearly nominal values.

An incident has occurred during **cycle 58** between 26/05/2007 and 30/05/2007. After a short transition period, the data are back to nominal.

A platform deficiency has occurred from 06/04/06 to 09/04/06 (**cycle 46**). Then, gain loss is observed for both channels on figures. A spike is also observed on 14/04/06 for both channels.

For cycle 45, a slight jump in the very last days of **cycle 45** is observed.

A big spike occurs on 01/02/06 during **cycle 44** for both channels.

Note that a step down on the gain values occurs during **cycle 36** for 36.5 GHz channel.

# ENVISAT MWR: Gain survey

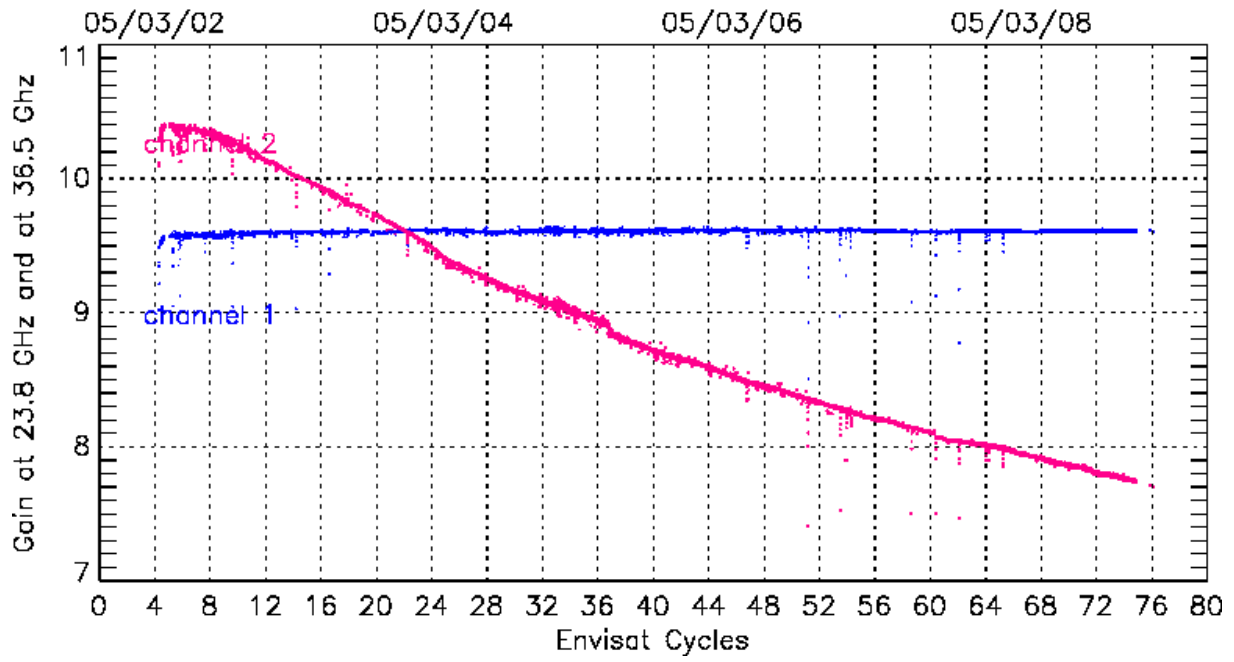

Figure 5: Time evolution of the gain since Envisat launch.

## 4.2 Sky horn and hot load counts survey

The sky horn counts on **figure 6** exhibit similar features than the gain for both channels. The counts present a very slight increase with time for the first channel. For the second one, the values drop from 3600 to 2783 (-22.69%).

The hot load counts on the same figure are stable for the first channel, around 553. They decrease for the second channel from 660 at launch time to about 636 (-3.64%).

During **cycle 71**, no MWR L0 data are available in Kiruna station from the 05 Sep 2008 to 07 Sept 2008. A step down is observed for the hot and cold counts of the 36.5 GHz channel.

Following a Payload HSM anomaly, no data are available from 17/01 8:50 to 17/01 18:41 during **cycle 65** which results on a small jump on hot load counts for channel 2.

Two planned unavailability periods (03/12 to 04/12 and 13/12 from 6 am to 12 am) during the cycle 64. Following the first unavailability period, a small drop on sky horn counts (both channels) is observed just as, on hot load counts, a drop for channel 1 and a decreasing slope for channel 2. Note that the drop on hot load counts for channel 1 almost balances the jump that has occurred after the incident at the beginning of **cycle 62**.

Following an anomaly within the on-ground mission control software, no data are available during the first four days of cycle 62 (24/09 to 27/09). After a short transition period, the counts have regained nominal values except for the hot load counts on channel 1 which seems to be stabilized at larger values. Following an anomaly within the on-ground mission control software, no data are available during the last nine hours of the **cycle 61** (24/09/2007).

Due to Telemetry error during **cycle 60**, the data from 29/07 to 30/07 are missing. After a transition period, instrumental parameters are back to nearly nominal values.

An incident has occurred during **cycle 58** between 26/05/2007 and 30/05/2007. After a short transition period, the data are back to nominal.

Note that spikes observed between 09/04/06 and 14/04/06 (**cycle 46**) are related to gain incidents invoked above.

A slight increase of hot load counts is observed in the very last days of **cycle 45** for first channel, while, for the second one, the increase is observed since the early days of this cycle.

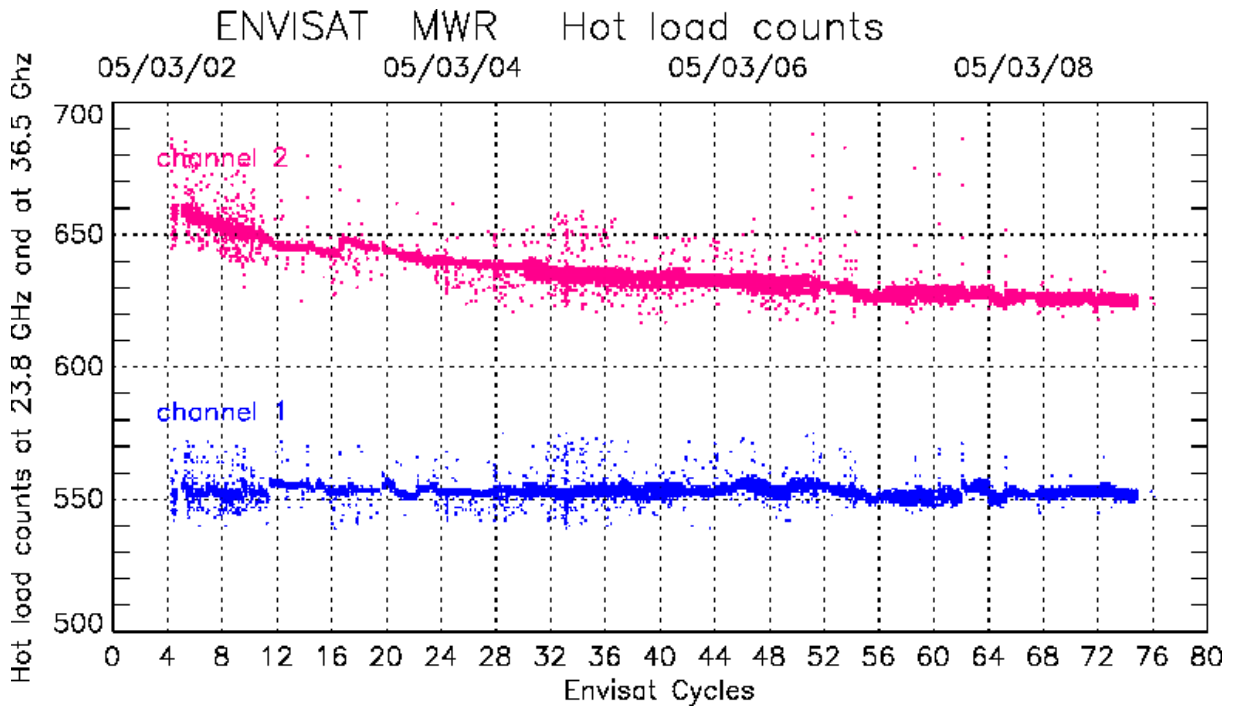
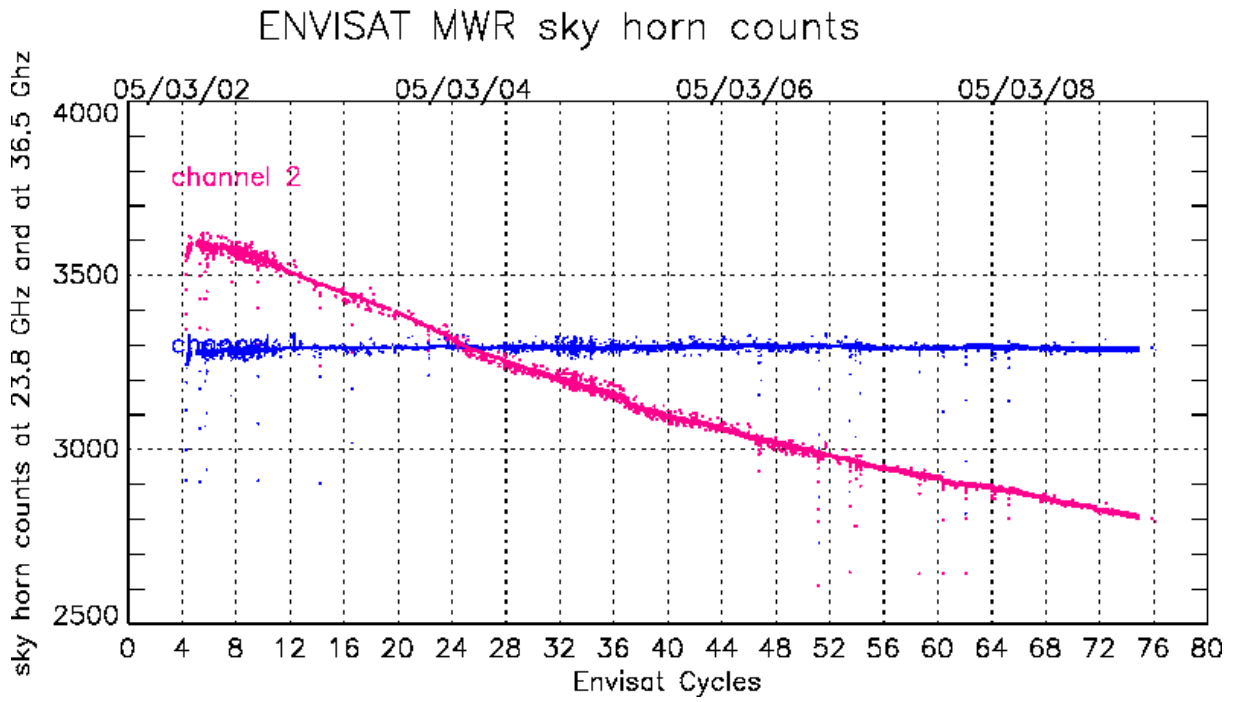

Figure 6: Time evolution of the sky horn (top) and hot load (bottom) counts since Envisat launch.



### 4.3 Residual temperature survey

**Figure 7** shows the residual temperature. Since launch, the values are higher than evaluated from ground testing. The residual temperature was expected to be around 0.5 K for the first channel and a bit higher, 0.5-0.7 K for the second one, i.e. close to the ERS ones (Eymard et al, 2002).

During **cycle 71**, no MWR L0 data are available in Kiruna station from the 05 Sep 2008 to 07 Sept 2008. A step down is observed for the residual temperature of the 36.5 GHz channel.

Following a Payload HSM anomaly, no data are available from 17/01 8:50 to 17/01 18:41 during **cycle 65** which results on a small jump on residual temperature for channel 2.

Two planned unavailability periods (03/12 to 04/12 and 13/12 from 6 am to 12 am) during cycle 64. Following the first unavailability period, a drop for channel 1 (-0.5 K) and a decreasing slope for channel 2 are observed. The drop on channel 1 seems to almost balance the jump of 0.5 K that occurred after the incident at the beginning of **cycle 62**.

Following an anomaly within the on-ground mission control software, no data are available during the first four days of **cycle 62** (24/09 to 27/09). After a short transition period, the residual temperature has regained nominal values on channel 2 but seems to be stabilized at larger values on channel 1.

Following an anomaly within the on-ground mission control software, no data are available during the last nine hours of the **cycle 61** (24/09/2007).

Due to Telemetry error during **cycle 60**, the data from 29/07 to 30/07 are missing. After a transition period, instrumental parameters are back to nearly nominal values.

An incident has occurred during **cycle 58** between 26/05/2007 and 30/05/2007. After a short transition period, the data are back to nominal.

Note that a big spike on 01/02/06 (**cycle 44**) for both channels are observed, as it is on gain values.

A residual temperature increase is observed after this spike for channel 1, during (**cycle 45**).

There are 4 particular features of this parameter to analyse:

- a drift of the residual temperature at 36.5 GHz, the values were down to -2.5 K with a regular linear decrease since 2-3 months after launch to cycle 16.
- a step is then observed with an increase of 0.5 K. The values were around -2.0 K and are decreasing again and are around -3.60 K.
- a step is observed at 23.8 GHz during cycle 11 with an increase of 0.5 K.
- a decrease is observed after the previous mentioned step for the 23.8 GHz channel. Since cycle 16, the values vary around 1.

# ENVISAT MWR: Residual temperature contributions TE

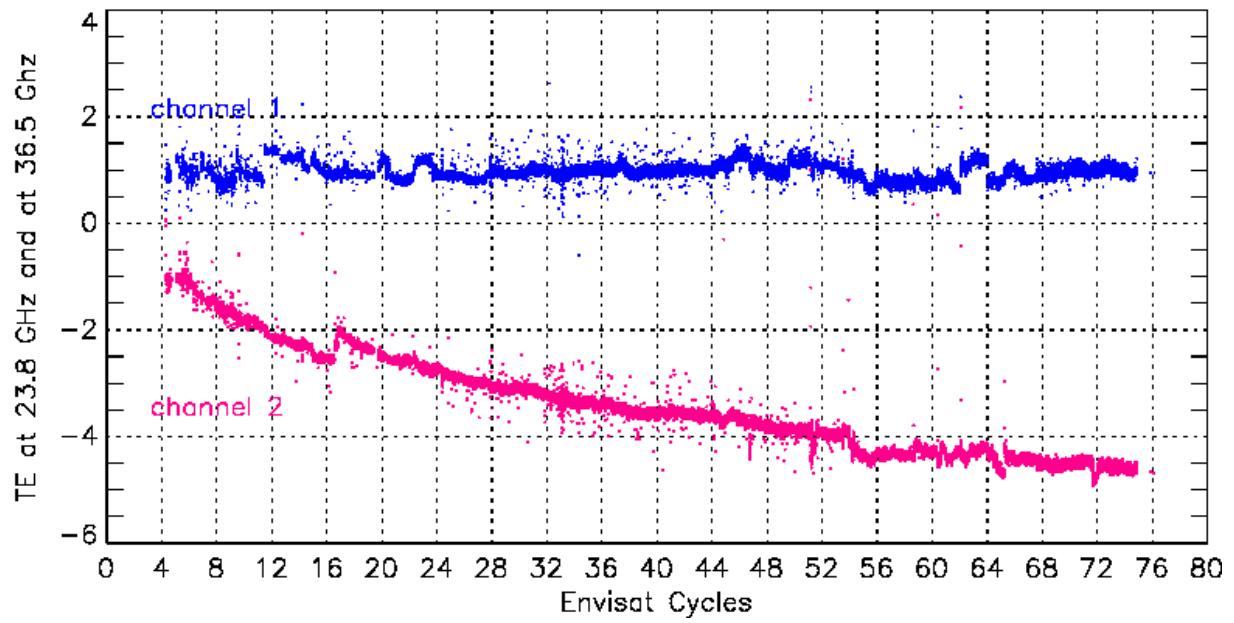

Figure 7: Time evolution of the residual temperature TE since Envisat launch.

## A Monitoring of the radiometer internal parameters

The radiometer telemetry primarily contains the radiometer counts for each channel, which are related to the brightness temperatures of the main antenna and the two calibration loads, through the working model (Bernard et al, 1993) summarized below:

$$\mathbf{T}_{fc} = acc \, ah0 \, \mathbf{TC} + (1 - acc) \, ah0 \, \mathbf{T}_{cc} + (1 - ah0) \mathbf{T}_h$$

$$\mathbf{G} = (C_c - C_f) / [ao + af \, \mathbf{T}_{fc} - ac \, \mathbf{T}_c + ah \, \mathbf{T}_h/c]$$

$$\mathbf{TE} = (C_c - off) / \mathbf{G} - aref \, \mathbf{T}_{ref} - ad \, \mathbf{T}_d + a2 \, \mathbf{T}_{fc} + a3 \, \mathbf{T}_h/c + a4 \, \mathbf{T}_c + a6 \, \mathbf{T}_{cal} + a5$$

$$\mathbf{T}'_a = b1 \, \mathbf{T}_{ref} + b2 \, \mathbf{T}_d - b3 \, \mathbf{T}_{cal} - b4 \, \mathbf{T}_c + \mathbf{TE} - (Ca - off) / \mathbf{G}$$

$$\mathbf{T}_a = c1 \, \mathbf{T}'_a - c2 \, \mathbf{T}_r$$

where the coefficients are derived from the primary coefficients shown in figure 8. The brightness temperature is then derived from the antenna measurement, by accounting for the reflector losses and side lobe contributions.

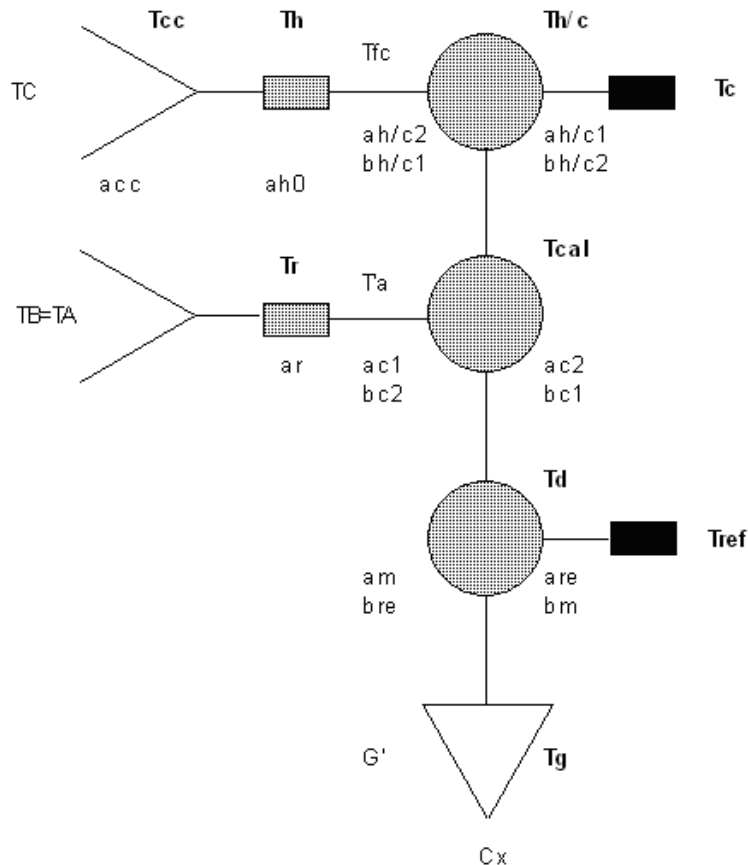

Figure 8: Scheme of one channel of the MWR, showing the main antenna, whose measurement is TA, the two calibration loads, consisting of an internal hot load and a sky horn, the reference load (Dicke load - temperature Tref) and internal switches to get every measurement. Each component is characterized by transmission and loss factors which are taken into account in the radiometer model, as well as their temperature.

## B References

---

### References

- [1] Bernard et al, *The microwave radiometer aboard ERS-1: Part 1 - characteristics and performances*, IEEE Trans. Geosci. Remote Sensing, 31(6), 1186-1198, 1993.
- [2] Eymard et al, *Intercomparison of TMR and ERS/MWR calibrations and drifts*, SWT TOPEX-JASON, New Orleans, Oct. 2002.
- [3] Eymard et al, *Reports on activities performed in 2001 on the ERS2/MWR survey*, May 2002.
- [4] Eymard et Obligis, *Preliminary report on long-term stability of ERS2/MWR over continental areas*, 1999.
- [5] Obligis et al, *An assessment of ENVISAT/MWR measurements and products*, Envisat QWG meeting, 26-27 September 2005, Toulouse, France.
- [6] Obligis et al, *Envisat/MWR: 36.5 GHz channel drift status*, March 2003.
- [7] Ruf, *Detection of calibration drifts in spaceborne microwave radiometers using a vicarious cold reference*, IEEE Trans. Geosci. Remote Sens., 38(1), 44-52, 2000.
- [8] Tran, Obligis, and Eymard, *Evaluation of Envisat MWR 36.5 GHz (updated status)*, CLS-DOS-NT-05-073 Report, 20 April 2005.