

ENVISAT Microwave Radiometer Assessment Report

Cycle 062

24-09-2007 – 29-10-2007

Prepared by :	B. PICARD, CLS E. OBLIGIS, CLS S. JOURDAIN, CLS L. EYMARD, LOCEAN/IPSL	
Checked by :	OZ. ZANIFE, CLS	
Approved by :	P. FEMENIAS, ESA	



Contents

1	Introduction	4
2	Synthesis	5
2.1	Conclusion for cycle 062	5
2.2	Long term monitoring	5
3	Significant events during cycle 062	7
3.1	Gain survey	7
3.2	Sky horn and hot load counts survey	8
3.3	Residual temperature survey	10
3.4	Cold ocean Tb monitoring	10
4	Long-term trends and former significant events	12
4.1	Gain survey	12
4.2	Sky horn and hot load counts survey	14
4.3	Residual temperature survey	16
A	Monitoring of the radiometer internal parameters	18
B	References	19

List of Figures

1	Time evolution of the gain (zoom on the last 3 cycles).	7
2	Time evolution of the sky horn (top) and hot load (bottom) counts (zoom on the last 3 cycles).	9
3	Time evolution of the residual temperature TE (zoom on the last 3 cycles).	10
4	Cold Ocean brightness temperature for the 23.8 Ghz channel (top) and the 36.5 GHz channel (bottom) (90 days running average).	11
5	Time evolution of the gain since Envisat launch.	13
6	Time evolution of the sky horn (top) and hot load (bottom) counts since Envisat launch.	15
7	Time evolution of the residual temperature TE since Envisat launch.	17
8	Scheme of one channel of the MWR	18

Editing modifications

Version	Date	Object
1.0	November 2007	Creation of the document.

1 Introduction

This document aims at reporting on the behavior of the ENVISAT Microwave Radiometer in terms of instrumental characteristics and quality of the brightness temperatures for cycle 062.

It is performed on the MWR level 1B data product. The decoding and pre-processing are done with the MWR level 1B reference processing chain located at CLS, using MWR level 0 data product as input (MWR_NL_OP). The data are from the ESA's ground stations in Kiruna, Sweden, and at ESRIN, Italy.

The objectives of this document are :

- to provide an instrumental status
- to check the stability of the instrument
- to report any change at the instrumental level likely to impact quality of the brightness temperatures

It is divided into the following topics:

- **Synthesis of cycle 062 events and long term monitoring**
- **Significant events during cycle 062**
- **Long-term trends and former significant events**

2 Synthesis

2.1 Conclusion for cycle 062

- **Following an anomaly within the on-ground mission control software, no data are available during the first four days of the cycle (24/09 to 27/09).**
- **After a short transition period, all the parameters have regained nominal values except for the hot load counts and the residual temperature, both on channel 1 (23.8 GHz).**
- **The bias of 0.5 K observed on the residual temperature should have a direct impact of about 0.7 K on the brightness temperatures and finally of about 3 mm of the wet tropospheric correction.**
- **A larger amount of data and further investigations are needed to study the detailed impact of this bias on the brightness temperatures and on the wet tropospheric correction in order to propose a proper correction.**

2.2 Long term monitoring

The monitoring of the main instrumental parameters of the radiometer up to cycle 062 shows a drift of the 36.5 GHz channel. It appears that the gain, the sky horn counts, and the hot load counts have decreased between 3 and 22.62% since launch.

Following an anomaly within the on-ground mission control software, no data are available during the first four days of **cycle 62** (24/09 to 27/09).

Following an anomaly within the on-ground mission control software, no data are available during the last nine hours of the **cycle 61** (24/09/2007).

Due to Telemetry error during **cycle 60**, the data from 29/07 to 30/07 are missing. After a transition period, instrumental parameters are back to nearly nominal values.

An incident has occurred during **cycle 58** between 26/05/2007 and 30/05/2007. After a short transition period, the data are back to nominal.

A big spike is also observed on 01/02/05 (**cycle 44**) for 23.8 GHz and 36.5 GHz channels.

A platform incident has occurred during **cycle 46**, between 06/04/06 and 09/04/06.

The residual temperature is now 3.50 times higher in absolute value than the one estimated at the beginning of the mission and 4-6 times higher than the one expected from ground testing. No explanation was provided up to now. These features should impact the 36.5 GHz brightness temperature as reported in (Obligis et al, 2003). But as seen in the monitoring of the cold ocean brightness temperatures through the different previous reports the slope of the derived regression line varies at each cycle which makes the quantification of the real impact difficult since the variation observed on the cold TB is a combination of the instrumental features and the annual natural cycle.

The table below sums up main monitoring anomalies observed since ENVISAT cycle 36 :

Cycle Number	Type of event	Date	Impacted Monitoring parameters
62	Unavailability	24/09/07 to 27/09/07	Unavailable L0 MWR data period. (anomaly within the on-ground mission control software)
61	Unavailability	24/09/07 to 24/09/07	Unavailable L0 MWR data period. (anomaly within the on-ground mission control software)
60	Unavailability	29/07/07 to 30/07/07	Unavailable L0 MWR data period. (Telemetry error)
58	Unavailability	26/05/07 to 30/05/07	MWR switched to Standby/Refuse mode after CEU (Central Electronic Unit) temperature uniformity flag was set to one. The situation was back to nominal after a COLD RESET of the DORIS/MWR ICU
53	Unavailability	30/11/06 and 15/12/06	Two unavailable L0 MWR data periods.
51	Unavailability	26/09/06 to 01/10/06	Unavailable L0 MWR data period.
51	Unavailability	07/09/06 to 11/09/06	Unavailable L0 MWR data period.
46	Quality	09/04/06	Gain loss, sky horn counts and hot load counts spikes for both channels.
44	Quality	01/02/06	Big spike on gain and TE values for both channels.
41	Quality	21/09/05	Spike on cold ocean TB values for both channels.
36	Quality	24/04/05	Gain values and sky horn counts step down for 36.5 GHz channel.

Table 1 : Main monitoring anomalies observed from cycle 36

3 Significant events during cycle 062

To monitor the instrument behaviour during its lifetime, the key parameters are plotted in figures 1, 2 and 3: gain (after correction of the thermal variations, modeled as a parabolic function), hot load and sky horn counts, and the residual term TE (residual temperature contribution due to errors in the estimated coefficients). The instrument stability is ensured if none of these parameters do vary with time (see the following paragraphs 3.1, 3.2 and 3.3).

On the other hand, to assess the long term stability of the MWR radiometer, a monitoring of the two brightness temperatures was performed by selecting the coldest measurements over ocean, as shown in figure 4. This method, derived from Ruf's one for TMR (Ruf, 2000), was found to be the most efficient to point out the slight trend of the ERS2 23.8 GHz channel (Eymard et Obligis, 1999; Eymard et al, 2002) (see the following paragraph 3.4).

3.1 Gain survey

Figure 1 represents the gains of the two channels 23.8 and 36.5 GHz since Envisat launch (top), and on the last three cycles (bottom).

The updated total decrease on channel 2 (36.5 GHz) is about 22.62% (from 10.4 at the beginning to about 8.048 now).

Following an anomaly within the on-ground mission control software, no data are available during the first four days of cycle 62 (24/09 to 27/09). After a short transition period, the gain has regained nominal values.

Following an anomaly within the on-ground mission control software, no data are available during the last nine hours of the cycle 61 (24/09/2007).

Due to Telemetry error during cycle 60, the data from 29/07 to 30/07 are missing. After a transition period, the gain measurements are back to nearly nominal values for the channel 1. For the channel 2, the measurements are stabilized at a slightly lower value.

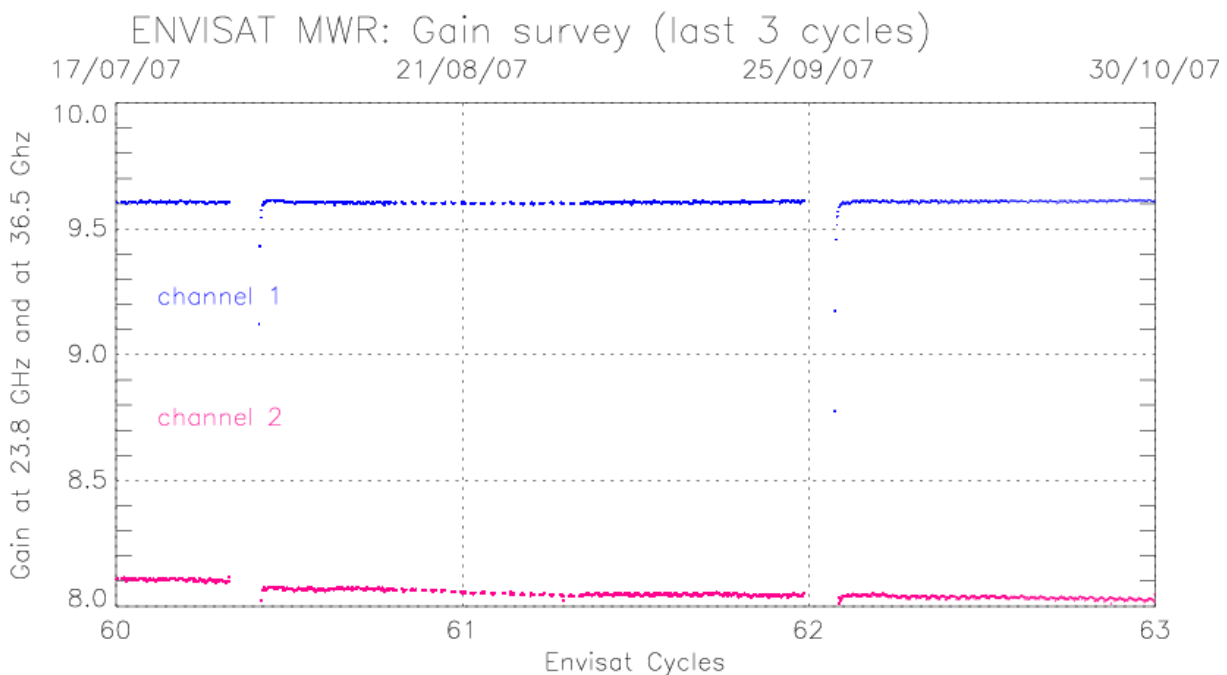

Figure 1: Time evolution of the gain (zoom on the last 3 cycles).

3.2 Sky horn and hot load counts survey

Following an anomaly within the on-ground mission control software, no data are available during the first four days of cycle 62 (24/09 to 27/09). After a short transition period, the counts have regained nominal values except for the hot load counts on channel 1 which seems to be stabilized at larger values.

Following an anomaly within the on-ground mission control software, no data are available during the last nine hours of the cycle 61 (24/09/2007).

Due to Telemetry error during cycle 60, the data from 29/07 to 30/07 are missing. After a transition period, sky horn counts are back to nearly nominal values. Concerning hot load counts, the values are slightly larger.

Figure 2 represents the counts of the two channels 23.8 and 36.5 GHz for the sky horn (top), and for the hot load (bottom).

The updated total decrease of sky horn counts on channel 2 (36.5 GHz) is about -19.61% (from 3600 at the beginning to about 2894 now).

The updated total decrease of hot load counts on channel 2 (36.5 GHz) is about -5.00% (from 660 at the beginning to about 627 now).

ENVISAT MWR sky horn counts (zoom on last 3 cycles)

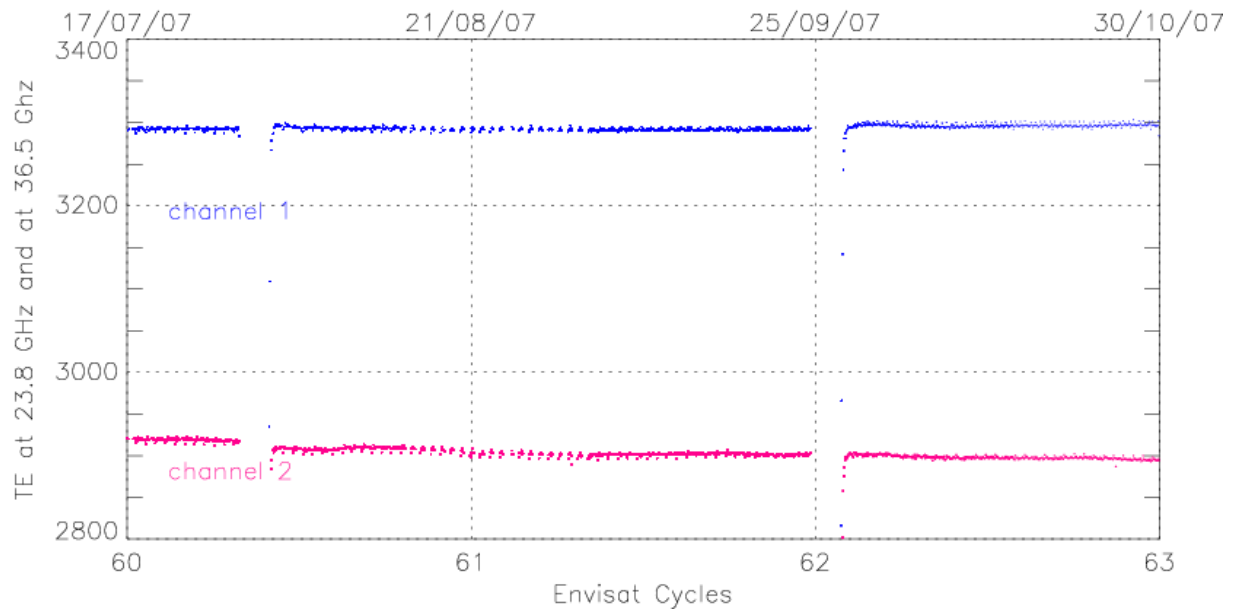

ENVISAT MWR Hot load counts (zoom on last 3 cycles)

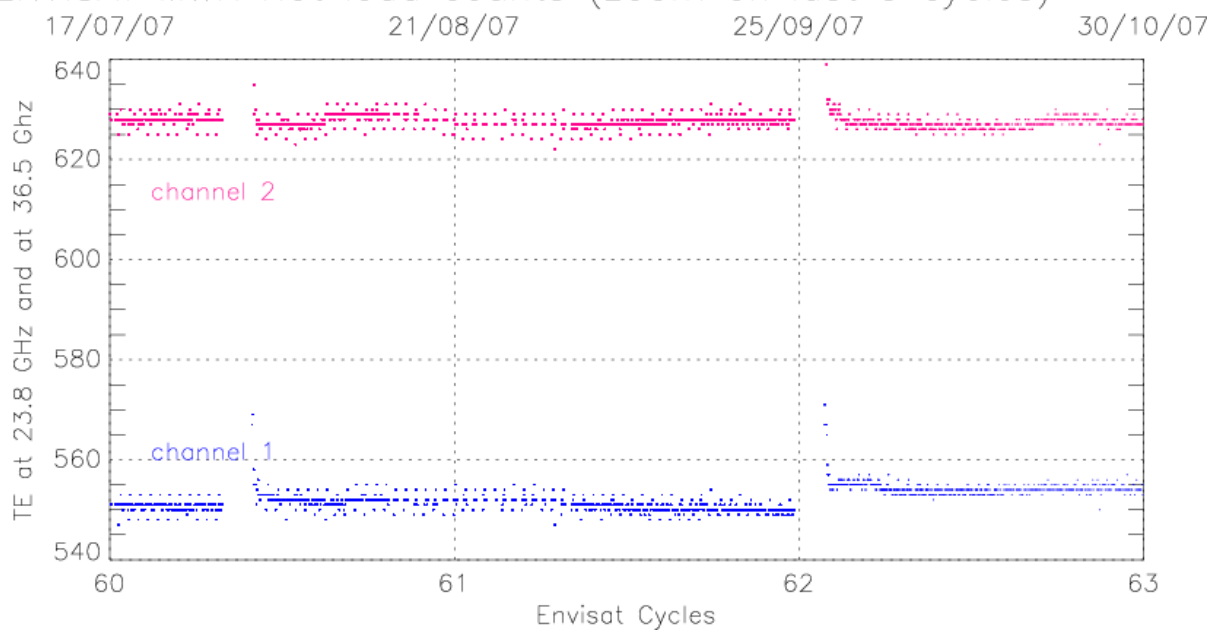

Figure 2: Time evolution of the sky horn (top) and hot load (bottom) counts (zoom on the last 3 cycles).

3.3 Residual temperature survey

Following an anomaly within the on-ground mission control software, no data are available during the first four days of cycle 62 (24/09 to 27/09). After a short transition period, the residual temperature has regained nominal values on channel 2 but seems to be stabilized at larger values on channel 1.

Values are nominal during cycle 61. Following an anomaly within the on-ground mission control software, no data are available during the last nine hours of the cycle (24/09/2007).

Due to Telemetry error during cycle 60, the data from 29/07 to 30/07 are missing. After a transition period, the residual temperatures seem to be stabilized at slightly larger values.

Figure 3 represents the residual temperature of the two channels 23.8 and 36.5 GHz since Envisat launch (top), and on the last three cycles (bottom).

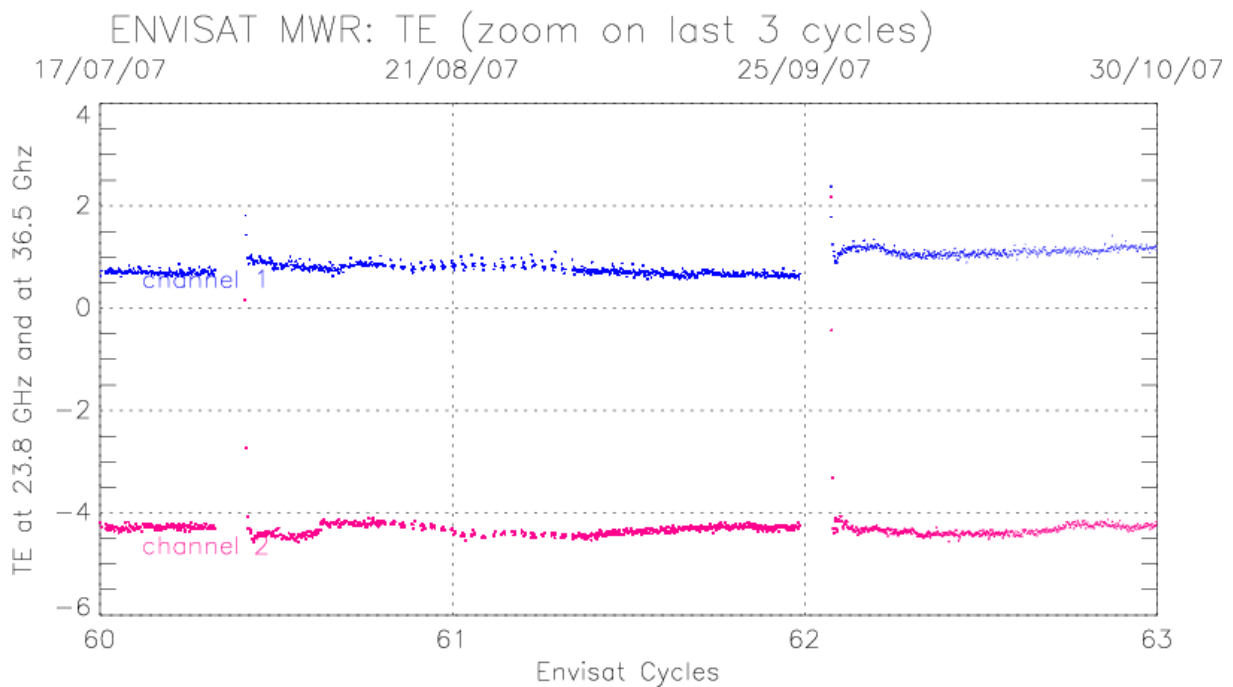

Figure 3: Time evolution of the residual temperature TE (zoom on the last 3 cycles).

3.4 Cold ocean Tb monitoring

Following the method explained above and using a threshold equal to the average minus the standard deviation, the Envisat resulting time series is plotted, after a 90-days running average, in **figure 4**. This running average leads to a small delay between the current cycle and the last available values of the cold ocean Tb monitoring.

For the first channel, the cold ocean TB values present a -0.024 K/year variation, while a variation of -0.032 K/year is observed for the second one.

On both channels, the cold ocean Tb are the most cold from cycle 29 to cycle 52 for the 23.8 GHz channel and from cycle 43 to cycle 52 for the 36.5 GHz channel (apart from the stabilization period, cycle 4 to 16). Since this phenomenon is observed on both channels, a geophysical origin is considered.

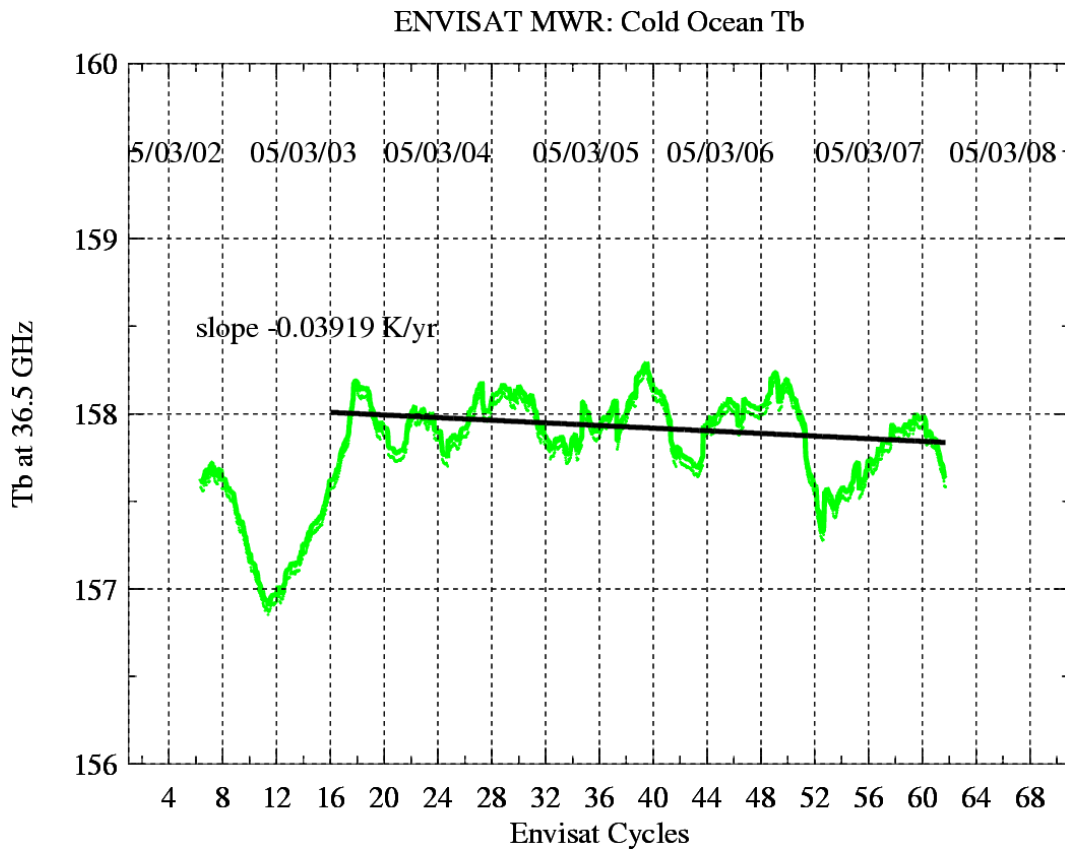
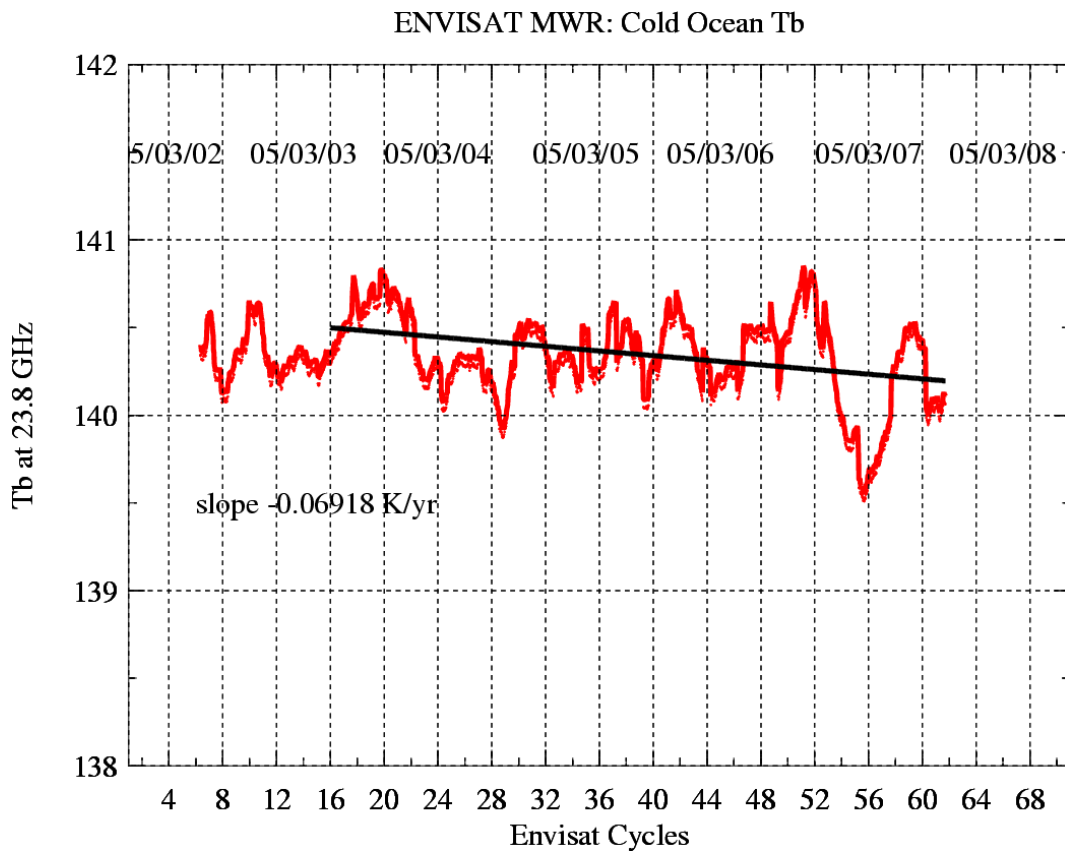

Figure 4: Cold Ocean brightness temperature for the 23.8 GHz channel (top) and the 36.5 GHz channel (bottom) (90 days running average).

4 Long-term trends and former significant events

4.1 Gain survey

Figure 5 shows that the gain in the 23.8 GHz channel remains stable around 9.6. For the second channel, the evolution shows two decreasing trends, small at the beginning and a stronger one since cycle 8. The total decrease is about 22.62% (at 10.4 at the beginning and about 8.048 now).

Following an anomaly within the on-ground mission control software, no data are available during the first four days of cycle 62 (24/09 to 27/09). After a short transition period, the gain has regained nominal values.

Following an anomaly within the on-ground mission control software, no data are available during the last nine hours of the **cycle 61** (24/09/2007).

Due to Telemetry error during **cycle 60**, the data from 29/07 to 30/07 are missing. After a transition period, instrumental parameters are back to nearly nominal values.

An incident has occurred during **cycle 58** between 26/05/2007 and 30/05/2007. After a short transition period, the data are back to nominal.

A platform deficiency has occurred from 06/04/06 to 09/04/06 (**cycle 46**). Then, gain loss is observed for both channels on figures. A spike is also observed on 14/04/06 for both channels.

For cycle 45, a slight jump in the very last days of **cycle 45** is observed.

A big spike occurs on 01/02/06 during **cycle 44** for both channels.

Note that a step down on the gain values occurs during **cycle 36** for 36.5 GHz channel.

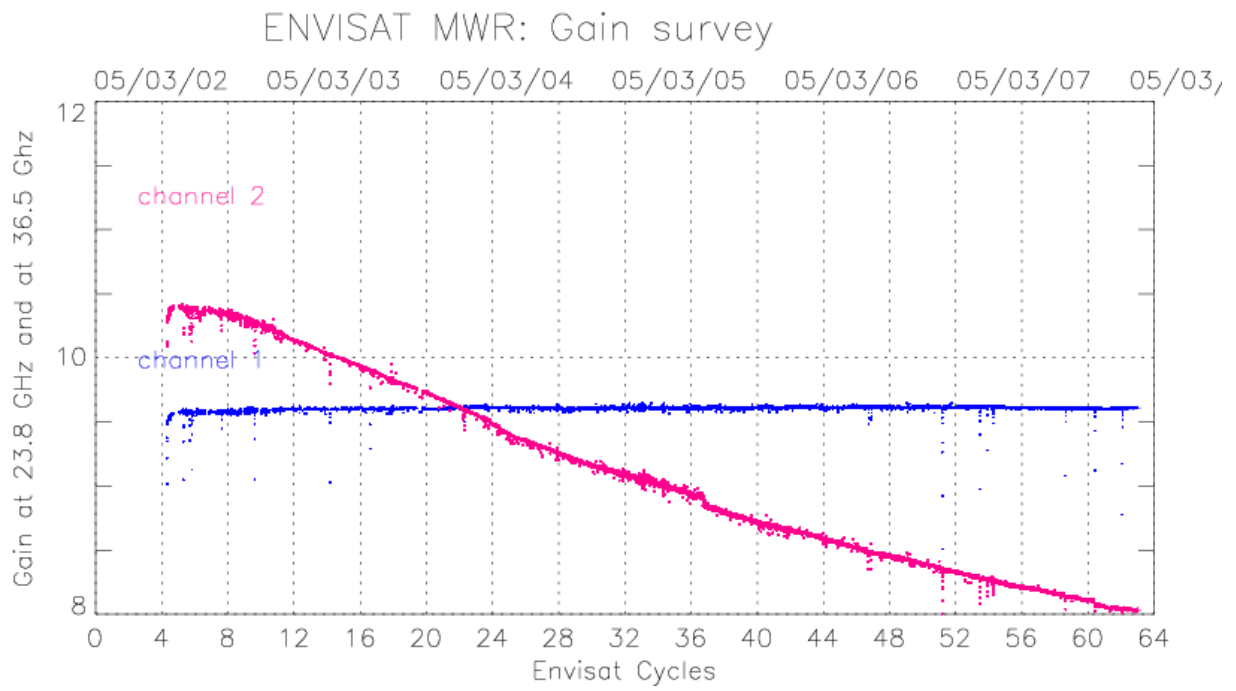

Figure 5: Time evolution of the gain since Envisat launch.

4.2 Sky horn and hot load counts survey

The sky horn counts on **figure 6** exhibit similar features than the gain for both channels. The counts present a very slight increase with time for the first channel. For the second one, the values drop from 3600 to 2894 (-19.61%).

The hot load counts on the same figure are stable for the first channel, around 553. They decrease for the second channel from 660 at launch time to about 636 (-3.64%).

Following an anomaly within the on-ground mission control software, no data are available during the first four days of cycle 62 (24/09 to 27/09). After a short transition period, the counts have regained nominal values except for the hot load counts on channel 1 which seems to be stabilized at larger values.

Following an anomaly within the on-ground mission control software, no data are available during the last nine hours of the **cycle 61** (24/09/2007).

Due to Telemetry error during **cycle 60**, the data from 29/07 to 30/07 are missing. After a transition period, instrumental parameters are back to nearly nominal values.

An incident has occurred during **cycle 58** between 26/05/2007 and 30/05/2007. After a short transition period, the data are back to nominal.

Note that spikes observed between 09/04/06 and 14/04/06 (**cycle 46**) are related to gain incidents invoked above.

A slight increase of hot load counts is observed in the very last days of **cycle 45** for first channel, while, for the second one, the increase is observed since the early days of this cycle.

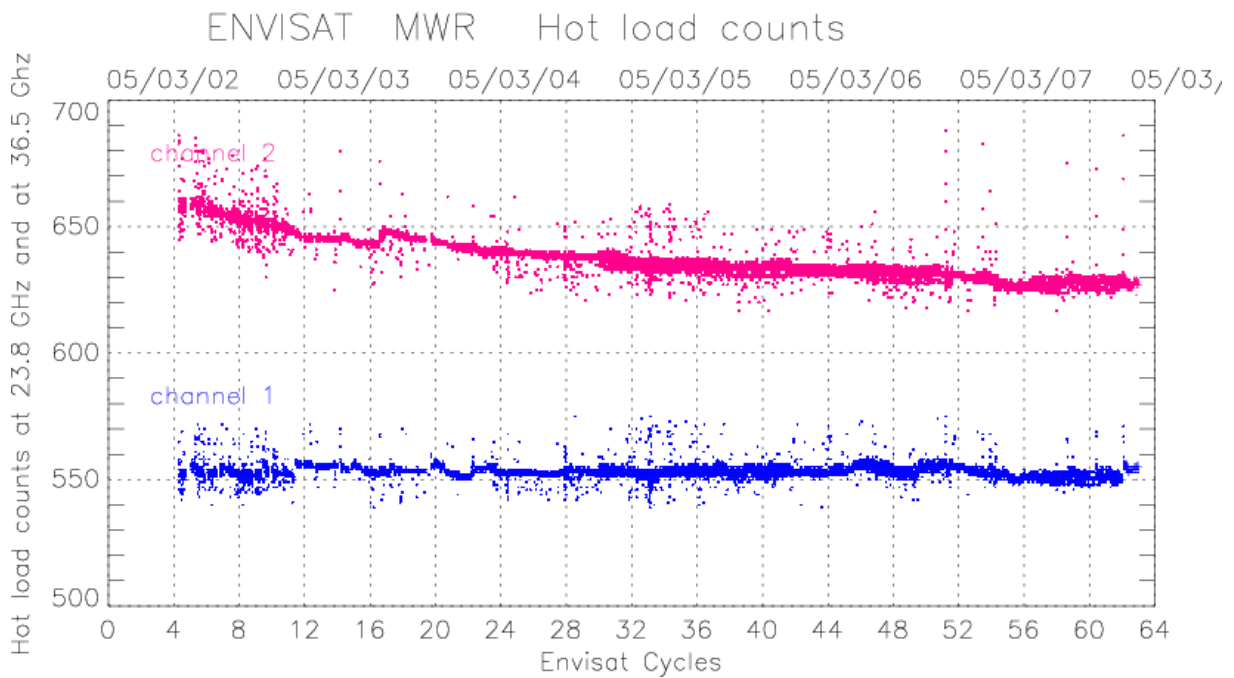
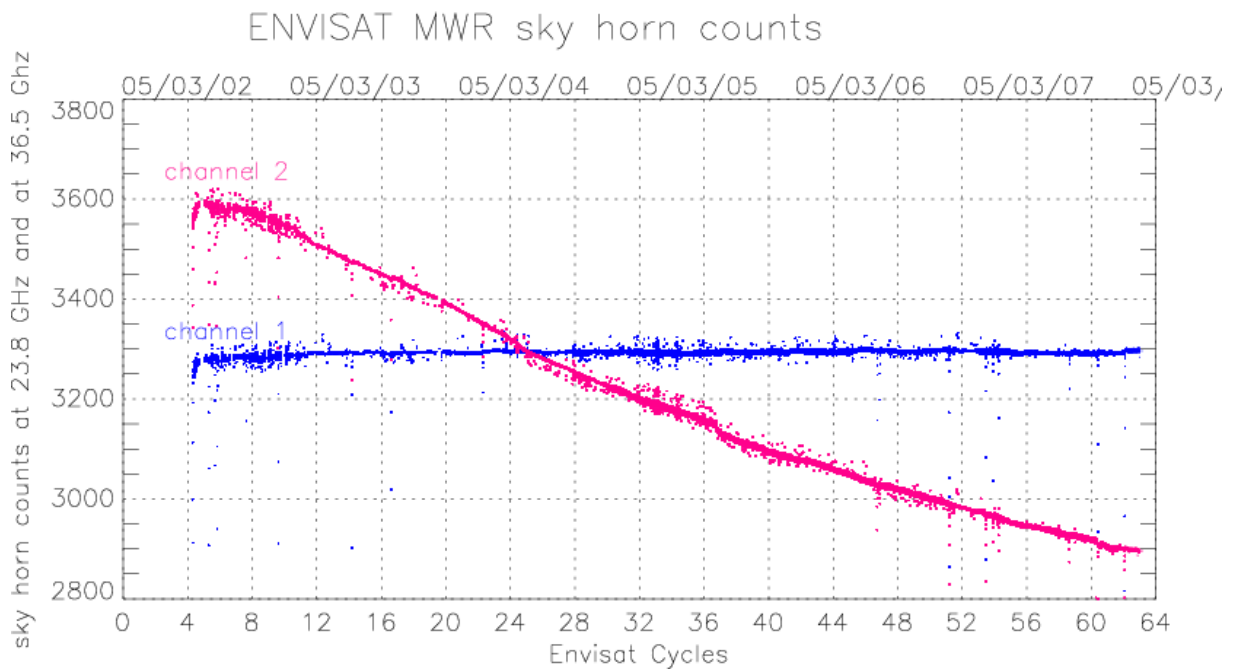

Figure 6: Time evolution of the sky horn (top) and hot load (bottom) counts since Envisat launch.

4.3 Residual temperature survey

Figure 7 shows the residual temperature. Since launch, the values are higher than evaluated from ground testing. The residual temperature was expected to be around 0.5 K for the first channel and a bit higher, 0.5-0.7 K for the second one, i.e. close to the ERS ones (Eymard et al, 2002).

Following an anomaly within the on-ground mission control software, no data are available during the first four days of cycle 62 (24/09 to 27/09). After a short transition period, the residual temperature has regained nominal values on channel 2 but seems to be stabilized at larger values on channel 1.

Following an anomaly within the on-ground mission control software, no data are available during the last nine hours of the **cycle 61** (24/09/2007).

Due to Telemetry error during **cycle 60**, the data from 29/07 to 30/07 are missing. After a transition period, instrumental parameters are back to nearly nominal values.

An incident has occurred during **cycle 58** between 26/05/2007 and 30/05/2007. After a short transition period, the data are back to nominal.

Note that a big spike on 01/02/06 (**cycle 44**) for both channels are observed, as it is on gain values.

A residual temperature increase is observed after this spike for channel 1, during (**cycle 45**).

There are 4 particular features of this parameter to analyse:

- a drift of the residual temperature at 36.5 GHz, the values were down to -2.5 K with a regular linear decrease since 2-3 months after launch to cycle 16.
- a step is then observed with an increase of 0.5 K. The values were around -2.0 K and are decreasing again and are around -3.60 K.
- a step is observed at 23.8 GHz during cycle 11 with an increase of 0.5 K.
- a decrease is observed after the previous mentioned step for the 23.8 GHz channel. Since cycle 16, the values vary around 1.

ENVISAT MWR: Residual temperature contributions TE

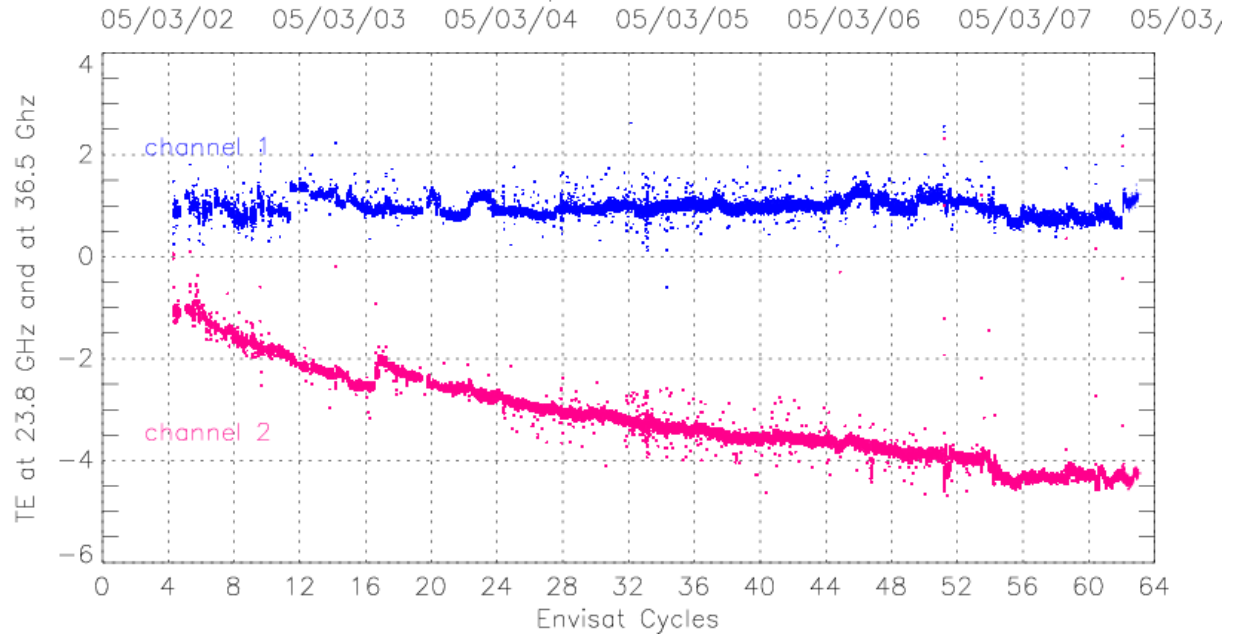

Figure 7: Time evolution of the residual temperature TE since Envisat launch.

A Monitoring of the radiometer internal parameters

The radiometer telemetry primarily contains the radiometer counts for each channel, which are related to the brightness temperatures of the main antenna and the two calibration loads, through the working model (Bernard et al, 1993) summarized below:

$$\mathbf{T}_{fc} = acc \, ah0 \, \mathbf{TC} + (1 - acc) \, ah0 \, \mathbf{T}_{cc} + (1 - ah0) \mathbf{T}_h$$

$$\mathbf{G} = (C_c - C_f) / [ao + af \, \mathbf{T}_{fc} - ac \, \mathbf{T}_c + ah \, \mathbf{T}_h/c]$$

$$\mathbf{TE} = (C_c - off) / \mathbf{G} - aref \, \mathbf{T}_{ref} - ad \, \mathbf{T}_d + a2 \, \mathbf{T}_{fc} + a3 \, \mathbf{T}_h/c + a4 \, \mathbf{T}_c + a6 \, \mathbf{T}_{cal} + a5$$

$$\mathbf{T}'_a = b1 \, \mathbf{T}_{ref} + b2 \, \mathbf{T}_d - b3 \, \mathbf{T}_{cal} - b4 \, \mathbf{T}_c + \mathbf{TE} - (Ca - off) / \mathbf{G}$$

$$\mathbf{T}_a = c1 \, \mathbf{T}'_a - c2 \, \mathbf{T}_r$$

where the coefficients are derived from the primary coefficients shown in figure 8. The brightness temperature is then derived from the antenna measurement, by accounting for the reflector losses and side lobe contributions.

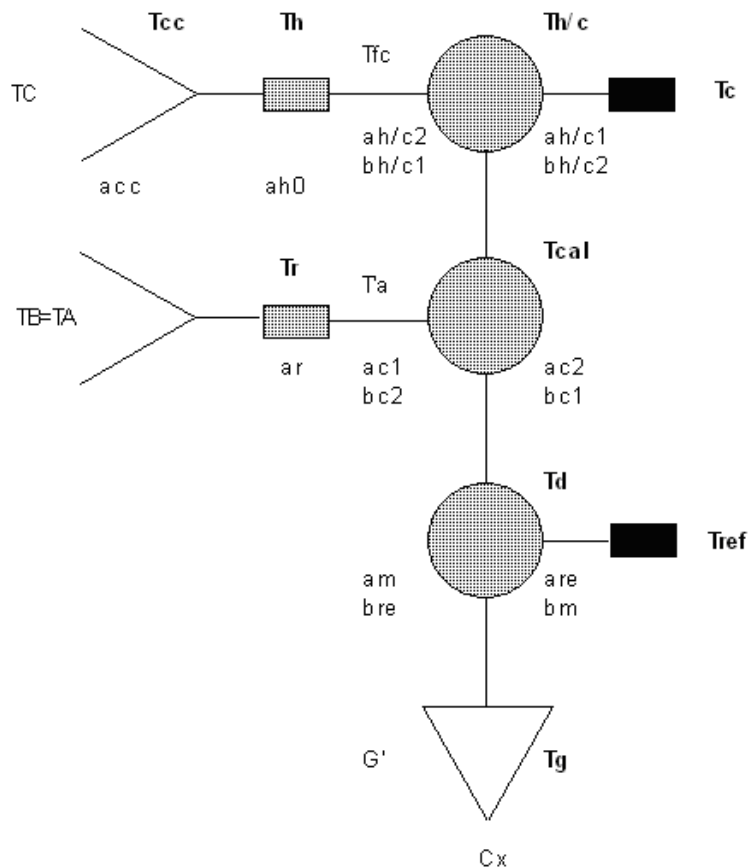

Figure 8: Scheme of one channel of the MWR, showing the main antenna, whose measurement is TA, the two calibration loads, consisting of an internal hot load and a sky horn, the reference load (Dicke load - temperature Tref) and internal switches to get every measurement. Each component is characterized by transmission and loss factors which are taken into account in the radiometer model, as well as their temperature.

B References

References

- [1] Bernard et al, *The microwave radiometer aboard ERS-1: Part 1 - characteristics and performances*, IEEE Trans. Geosci. Remote Sensing, 31(6), 1186-1198, 1993.

- [2] Eymard et al, *Intercomparison of TMR and ERS/MWR calibrations and drifts*, SWT TOPEX-JASON, New Orleans, Oct. 2002.

- [3] Eymard et al, *Reports on activities performed in 2001 on the ERS2/MWR survey*, May 2002.

- [4] Eymard et Obligis, *Preliminary report on long-term stability of ERS2/MWR over continental areas*, 1999.

- [5] Obligis et al, *An assessment of ENVISAT/MWR measurements and products*, Envisat QWG meeting, 26-27 September 2005, Toulouse, France.

- [6] Obligis et al, *Envisat/MWR: 36.5 GHz channel drift status*, March 2003.

- [7] Ruf, *Detection of calibration drifts in spaceborne microwave radiometers using a vicarious cold reference*, IEEE Trans. Geosci. Remote Sens., 38(1), 44-52, 2000.

- [8] Tran, Obligis, and Eymard, *Evaluation of Envisat MWR 36.5 GHz (updated status)*, CLS-DOS-NT-05-073 Report, 20 April 2005.